



FEEDERS & HANDLING EQUIPMENT



Schummer ENT

Formerly Mar-Weld

2024 Catalog

SHEEP/GOAT HANDLING

Deluxe Spin Trim Chute

#DST Handles animals for hoof trimming, vaccination, de-worming and tagging



Pads optional
(sold seperately)

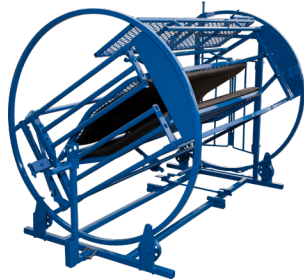

NAME



#DST Deluxe Spin Trim Chute

All-in-one spinning hoof trimmer & self-catching head gate

Makes less appealing tasks easier

Fully adjustable to fit all sizes of sheep & goats

Shown with padded sides (Sold Separately)

Dimensions 62"l x 43"w x 45"h

SHEEP/GOAT HANDLING



Head Gate & Chute
#SCHHG Self-catching head gate and chute

Self-Catch Head Gate
#SGHG Mounts to your existing alley or chute



NEW



Analog Scale
#PN440L Sheep and goat scale



Analog Scale
#PN440 Sheep and goat scale

3 Style Scales Available with Dial or Digital Heads

Digital Scale With Head Gate
#PN440HD Digital scale with self-catching head gate



#SGHG Self-Catch Head Gate
Dimensions 20"w x 40"h

#SCHHG Head Gate & Chute
Ideal for vaccinations, de-worming, tagging, etc
Attaches to front of #WCCT working chute
Both sides open for easy access
Dimensions 54"l x 20"w x 40"h

#PN440L Analog Scale

#PN440 Analog Scale
Both doors open from same end
Shorter wheel base for easier maneuverability
Also ideal for shipping hogs
Solid wheels & slatted floor
Optional digital display
Dimensions 52"l x 28"w x 56"h
Weight Capacity 440 lbs

#PN440HD Digital Scale With Head Gate

Unique all-in-one design for weighing & processing
#PN440H Optional analog display
Dimensions 60"l x 28"w x 56"h

SHEEP/GOAT HANDLING

Folding Stop Gate

#FSG Connects to raceway for extra stopping



Sliding Stop Gate

#SSG Connects to raceway for extra stopping



2 Way Sheep Sorter

#2WSS 2-way Sorting with Stop



NEW

NEW

Double Extended Ally Support

#WUSD



NEW

Ally Support for Front of DST

#WUSF



#FSG Folding Stop Gate

Connects to raceway for extra stopping

Dimensions 20"w x 36"h

#SSG Sliding Stop Gate

Connects to raceway for extra stopping

#WUSD Double Extended Ally Support

#WUSF Ally Support for Front of DST

SHEEP/GOAT HANDLING

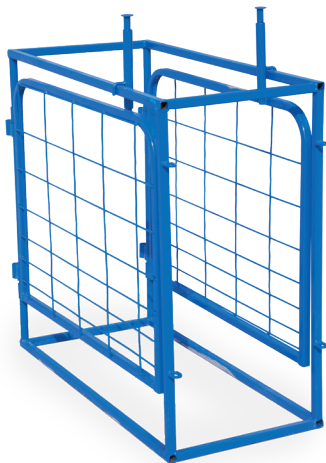

Sheep Sorter
#3WS 3-way animal sorter

Sheep Sorter
#WCG 2-way animal sorter



Working Chute & Crowding Tub
#WCCT Fast easy way to handle sheep

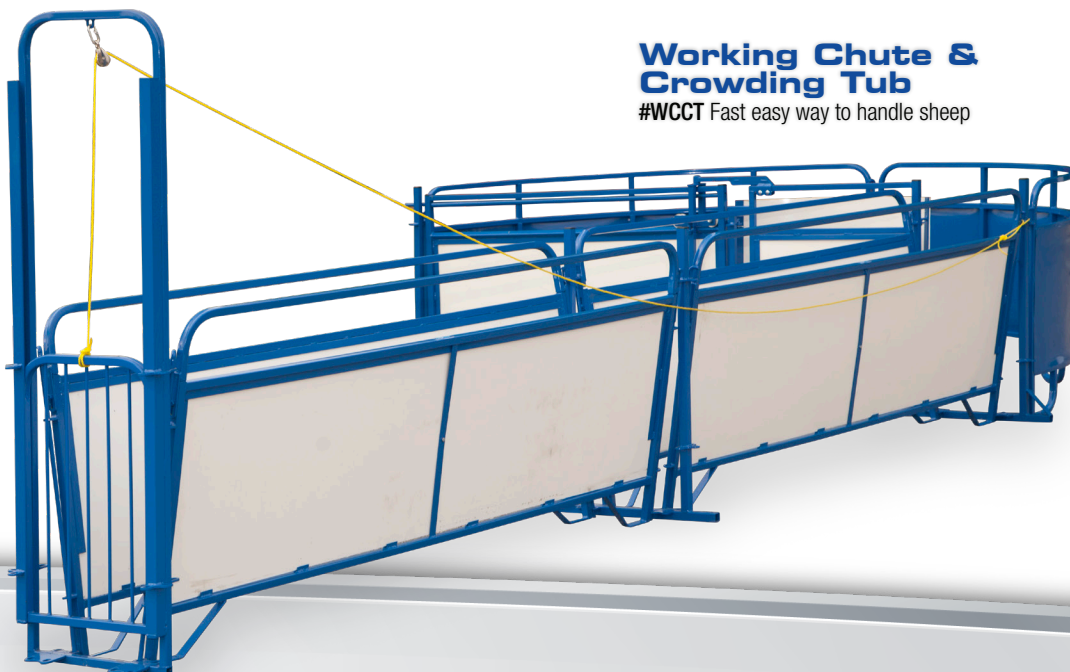

#3WS Sheep Sorter

Connects to front of raceway for easy 3-way sorting of animals

Dimensions 42"l x 20"w x 40"h

#WCG Sheep Sorter

Connects to front of raceway for easy 2-way sorting of animals

Dimensions 42"l x 20"w x 40"h

#2WSS 2 Way Sheep Sorter

#WCCT Working Chute & Crowding Tub

FEATURES: White plastic sides for better sheep flow / top bar folds down/pull-out revolving door/ now tub is fully reversible

Unique design allows all sections to be interchanged

1" x 1" tube frames with 24" height white plastic sides

18" wide chute can be narrowed to 10" at bottom for lambs

Length of chute can easily be extended by adding extra sections

Guillotines can be inserted anywhere along the chute

Versatile design allows the unit to adapt quickly and efficiently to your operation

Extra Components Spin trim chute, scales, head gates, sorters, extra panels (sold separately)

#WSP Straight Panel 8'l x 40"h

#WCT Tub Only 5'd x 40"h

#WGG Guillotine Gate 20"w x 72"h

#WAB Anti-backup

#WUS Extra Ally Supports

BASKET FEEDERS

Basket Feeder For Sheep

#SHB For bales up to 5' x 5'



Basket Feeder For Sheep

#SHBP 14 ga steel pan beneath for catching loose hay

Basket Feeder For Goats

#GOB Basket height position built specifically for goats



Round Feeder

#2PCS Portable 2-piece feeder for loose hay & round or square bales



Lamb Creep Feeder

#612LF 6' x 6' creep feeder for lambs

NEW Adjustable feed flow

#SHB Basket Feeder For Sheep

1¼" square tube frame
1½" x ¼" flat hoops with 7¼" spacing
Stacks nicely for transport

Dimensions 66"l x 66"w x 45"h

#SHBP Basket Feeder For Sheep

1¼" square tube frame
1½" x ¼" flat hoops with 7¼" spacing
Stacks nicely for transport

For bales up to 5' x 5'

Dimensions 66"l x 66"w x 51"h

#GOB Basket Feeder For Goats

1¼" square tube frame
1½" x ¼" flat hoops with 6" spacing
Stacks nicely for transport
Access door on end makes bale loading easy

Dimensions 64"l x 66"w x 57"h

#2PCS Round Feeder

28 feeding spaces
Ideal for temporary confinement
12" metal skirt
6½" slanted rod spacing
Easy-connect system

Dimensions 5½'d x 36"h

#612LF Lamb Creep Feeder

12 bu 14 ga MIG welded steel tank
Adjustable openings on creep panel end gate
Slide-back water proof lid
Moves easily on skids
Collapsible for easy shipping and transport

SHEEP/GOAT FEEDERS



Walk-Through Feeder

#WTF Feeds small square bales and grain



Bale & Grain Feeder

#WTB Feeds large square bales & grain

Single-Sided Feeder

#SSF Feeds hay & grain

NEW

Improved design for better feed flow



Collapsible Feeder

#3CF Completely collapsible hay feeder with 3" rod spacing

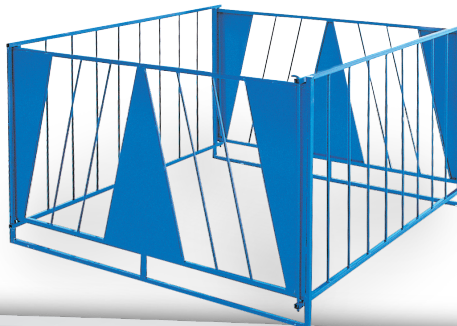

Collapsible Feeder

#7CF Completely collapsible hay feeder with 7" rod spacing

#WTF Walk Through Hay & Grain Feeder

Basket rod spacing is 2 $\frac{3}{4}$ "
8" alley through centre of feeder
Attach multiple feeders end-to-end by removing doors
Stacks nicely for transport

Dimensions 96"l x 36"w x 38"h

#WTB Bale & Grain Feeder

Improved design for better bale flow
Removable wool guards for maximum bale flow
Basket rod spacing is 3"

Dimensions 96"l x 48"w x 42"h

Designed for bales up to 3' x 3' x 7 $\frac{1}{2}$ '

#SSF Single-Sided Feeder

2 $\frac{3}{4}$ " rod spacing
Full sheet metal back keeps lambs from escaping underneath
1" x 1" tube frame, 14 ga sheet metal
Dimensions 8 and 10'l (standard) x 18"w x 36"h
Custom lengths also available

#3CF Collapsible Feeder

3" rod spacing
Closer bar spacing allows hay to come through but keeps chaff out of wool
Dimensions 72"l x 72"w x 44"h

#7CF Collapsible Feeder

7" rod spacing
Slanted rods on sides prevent sheep from getting caught as ends move in
Dimensions 72"l x 72"w x 44"h

SHEEP/GOAT FEEDERS

Round Bale Feeder

#BR5 For large round bales up to 5'



Round & Square Bale Feeder

#LSF08 For large round or square bales



Bunk Feeder

#BF96 Bunk feeder with 10 feeding spaces

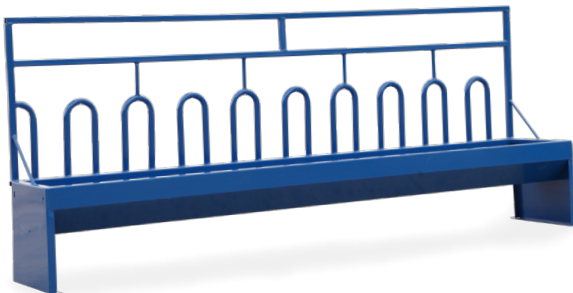

Small Bale Feeder

#SB8 Small bale feeder with 26 feeding spaces

Small Bale Feeder

#SB4 Small bale feeder with 15 feeding spaces



#BR5 Round Bale Feeder

22 feeding spaces
For large round & square bales up to 5'
Tombstone design for less hay wastage
Dimensions 62"l x 67"w x 56"h

#LSF08 Round & Square Bale Feeder

Fits large square bales up to 7'
Tombstone design for less hay wastage
Mesh in Basket to hold Flakes Better
Dimensions 96"l x 67"w x 56"h

#BF96 Bunk Feeder

10 feeding spaces (tombstone or slant bar)
Works as free standing unit or can be attached to make a feed front
Feeds hay & grain
Dimensions 96"l x 16"w x 40"h

#BF120 Also available or custom length

#SB8 Small Bale Feeder

26 feeding spaces
Design forces goats to lift heads to enter and exit feeder, reducing wastage
Feeds hay & grain
Dimensions 96"l x 44"w x 38"h

#SB4 Small Bale Feeder

15 feeding spaces
Same as above, but 4' length

SHEEP/GOAT MILKING

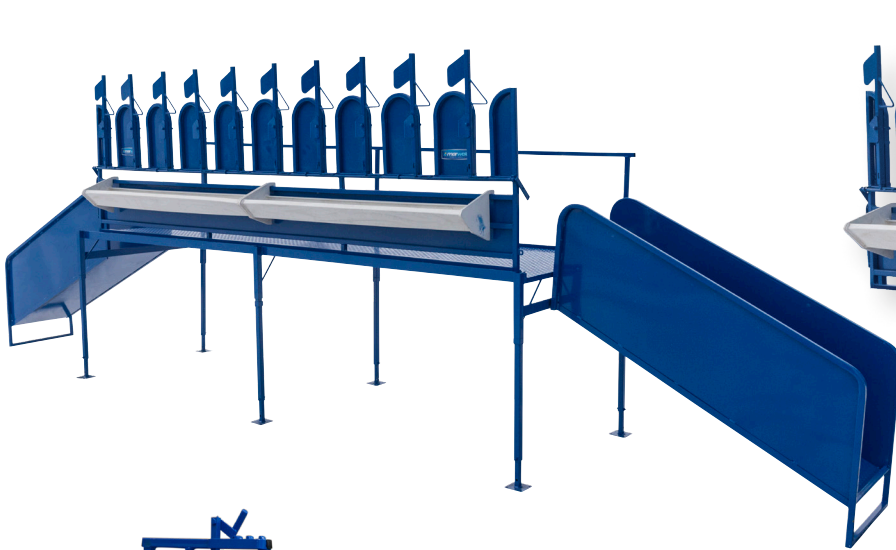

Milking Stand

#GMS100 Fully collapsible self-locking head rail on a stand

Single Animal Milking Show Stand

#SHGS

NEW



Loading Chute

#LCFS Portable loading chute for sheep & goats

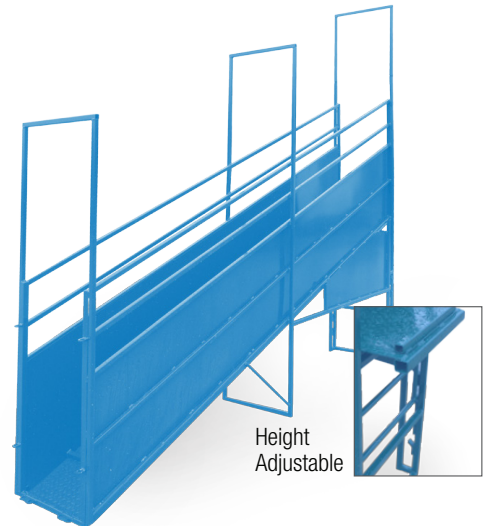

Height Adjustable

#GMS100 Milking Stand NEW Tombstone Style

Individual entry self-locking head rail on stand
Fully collapsible for easy transportation and installation

Custom built to your dimensions
Height adjustable from 36" to 40"

Available with ramps or steps (sold separately)

Plastic Grain Trough Included with part # GH100 and GMS100

#LCFS Loading Chute

Portable chute for sheep & goats
Height adjustable from 18-48"

Dimensions 12'l x 20'w

#SHGS Single Animal Milking Show Stand

SHEEP/GOAT PENNING

Economy Lambing Pens

4' x 5' portable lambing pen

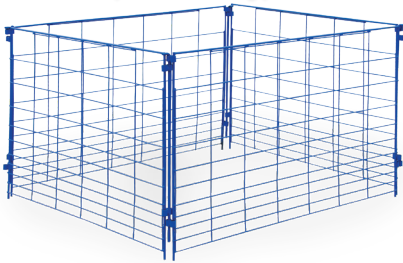

Sold Per Panel

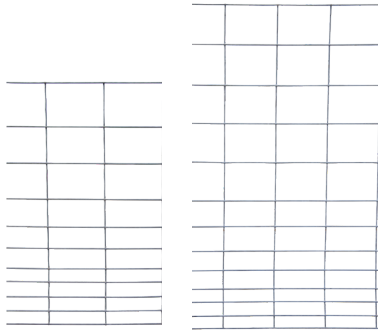

Hog Panel

All-purpose wire mesh (left)

Cattle Panel

All-purpose wire mesh (right)

2x4 Mesh 4x16ft Panels Also Available

4x4 Mesh 3x16ft Panels Also Available

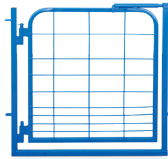

Door

#3WT Wire mesh man door

4ft and 5ft Also Available



Lambing Pens

4' x 5' portable lambing pen

Sold Per Panel



Creep Panel

#RCP Creep panels with adjustable PVC rollers

6ft Also Available

4 FT Grafting Panel

#4GP

*5 foot also available



#3WT Door

Wire mesh man door

Connects to gates and panels for easy access to pens

Dimensions 36" w x 40" h

#4WT Door

Dimensions 48" x 40"

#5WT Door

Dimensions 60" x 40"

Hog Panel

4 ga galvanized wire

Dimensions 16'l x 34"h

Cattle Panel

4 ga galvanized wire

Dimensions 16'l x 50"h

Economy Lambing Pens

Light-weight wire mesh panels 36" high

Create a second pen with only 3 more panels

#5EP 5' Mesh Panel

#4EP 4' Mesh Panel

Lambing Pens

1" x 1" square tube frame with 12" skirt & 3/8" rods

Create a second pen with only 3 more panels

#5LP 5' Panel

#4LP 4' Panel

#RCP Creep Panel

Up to 4' openings with PVC rollers

Dimensions 48" w x 36" h

#RCP6 6' Model available

#4GP 4ft Grafting Panel

#5GP 4ft Grafting Panel

Fits anywhere with EP or LP Panel

Great for Ewes that are Hard to Bond

SHEEP/GOAT PENNING



Feed Front

#PTF96 Can be used as a gate or feed front

Hay Rack Sold Separate #HHR

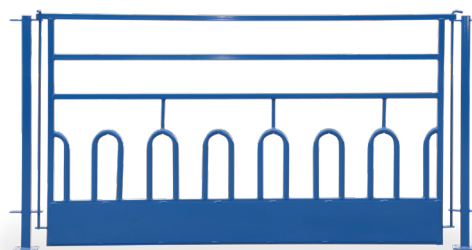

Feed Front

#TFS Tombstone style feed front for sheep

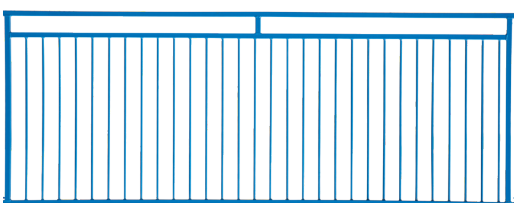

Spindle Section

#SSP Can be used as gates or penning

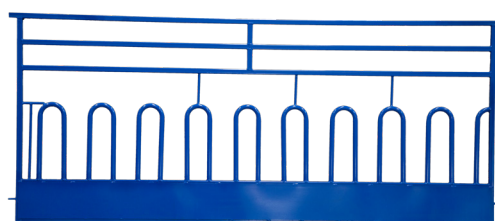

Feed Front

#TFG Tombstone style feed front for goats

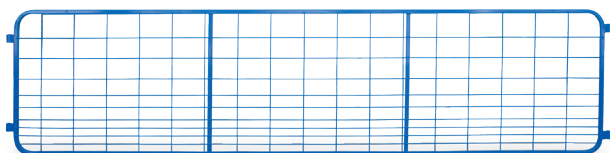

"WMDL Series" Divider

#WMDL Wire mesh divider or gate



Slant Bar Manger

#SBF Slant bar manger for sheep

#PTF96 Feed Front (smaller animals)

40" High Total Height (On Posts)
Feed Opening at 8" From Ground
1x1 Tube Frame 7/16th Rod Spindles 3" spacing
Adjustable bar for feed opening
Removable Poly Trough
Post sold separately

#HHR Hanging Hay Rack (sold separately)

#TFS Tombstone Feed Front For Sheep

Designed for Floor Feeding
8" Skirt Keeps Muck Out of Feed
Lower tombstone better access for Sheep
40" High total 20" to top of tombstone
Post sold separately

#SSP Gates and Penning

1x1 Tube Frame 7/16th Rods 3" Spacing
40" Total Height on Posts
Can Also Be Made a Gate W/Eyes & Chain
(8' section shown) Post sold separately
Both styles 36" High x any Length
Dimensions 36" h x any length
#SG36 Spindle Gates

#TFG Tombstone Feed Front For Sheep

8" Skirt Keeps Muck out of Feed
40" High 24" to Top of Tombstone

#WMDL Divider or Gate

1" x 1" tube frame & with wire mesh
Sections link together with 5/8" pins
Links compatible with #SBF
Also available with chain on one end and eyes on other end
Dimensions 4' - 16' x 36" h

#SBF Slant Bar Manger

1" x 1" tube frame with 12" skirt
1/2" slant rods with 7" spacing
Sections link together with 5/8" pins
Dimensions 8', 10' & 12' l x 36" h

Show Penning

NEW



NEW



Small Bale Upright Feeder
#SBUF

Show Penning

46" High Panels
12" Skirt
32" Rods
3" o/c Spacing
Available 4', 5', 6', 7', 8'

Mandoors
Door Comes with 2 way Self Closing
Available in 4', 6'

#SBUF Small Bale Upright Feeder

Come completely Collapsed
Fit 1 Small Square Bale

Dimensions: 21" x 21" x 42"



Square Wool Bag Stand
#WBS

*bag not included

NEW

NEW

10" Hook on Pail Holder
#10PH

Pail and Hook Sold Separately!

8 Qt Black Pail
#8QP

Self Locking Head Rail
#SGSL Self locking head rail for sheep & goats



#WBS Square Wool Bag Stand

Comes collapsed

Fit Square bag from Canadian Cool wool Growers

#10PH 10" Hook on Pail Holder

#8QP 8 Qt Black Pail

#SGSL Self Locking Head Rail

Self locking head rail for sheep and goats

Sold per lock

Can make any length to work as 1 long Headrail



Hay Rack
#SHRP4

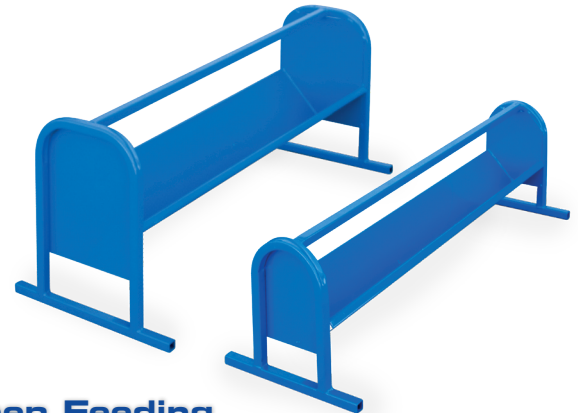

Creep Feeding Trough
Creep feeding troughs for goats and sheep



Hay Rack
#SHR Small hay rack, holds one flake of hay
24"l x 18"h x 12"w

Hay Rack
#SHRP Ideal for hanging in small Pens for Kids/Lambs or Mature animals
Includes trough for feeding grain/Catch Fines
24"l x 24"h x 12"w



Creep Feeding Trough

#LCF 48"l x 12"w x 12"h

#SCF 48"l x 8"w x 8"h

#SHR Small Hay Rack

Ideal for hanging in small pens for kids or mature animals

Dimensions 24"l x 12"w x 18"h

#SHRP4 Hay Rack

Ideal for Feed Small Bale to Small Group trough for Creep Feed

Dimensions: 24" x 48" x 12"

#SHRP Hay Rack

Ideal for hanging in small Pens for Kids/Lambs or Mature animals
Includes trough for feeding grain/Catch Fines

Dimensions 24"l x 24"h x 12"w



Plastic Grain Feeder

#PGF Plastic grain feeder with 1" lip to prevent feed spillage

Plastic Hay and Grain Feeder

#SPHR



3 Section Rubber Weather Proof Mineral Feeder

#MF-99

NEW



NEW



Plastic 24" 3 Hole Creep Feeder

#PCF24

NEW



Plastic 48" 6 Hole Creep Feeder

#PCF48

#PGF Plastic Grain Feeder

Comes in 2', 4', 5', 6', and 8' lengths

Dimensions 8' l x 3½" d

3 Section Rubber Weather Proof Mineral Feeder

Ideal for Keeping your minerals dry on pasture

32" Diameter x 11" High

#SPHR Plastic Hay and Grain Feeder

Feeds hay and grain

Adjustable Hanging Hook

Dimensions 24" x 24" x 12"

#PCF24 Plastic 24" 3 Hole Creep Feeder

Dimensions 48" x 24" x 10"

#PCF48 Plastic 48" 6 Hole Creep Feeder

Dimensions 24" x 24" x 12"

ACCESSORIES

#LWALP
Long Wall
Bracket



#PT40 Post
40" post with 4"
floor plate
2W
3W
4W
C

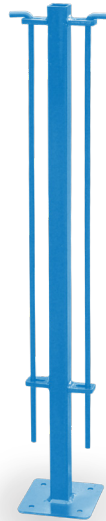

#SPLW Weld-on
Spring Latch



#WOE
Weld-on
Eye

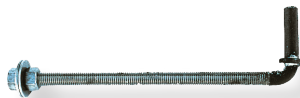

#HA 16" Black Hanger



#GALV 12" Galvanized
Hanger



#LSH Lag Screw Hanger



#WOH Weld-on
Hanger



#WOW Weld-on
Wall Bracket